

*Advanced Information*

**SMARTDISCRETES** <sup>TM</sup>

**Internally Clamped, N-Channel IGBT**

This Logic Level Insulated Gate Bipolar Transistor (IGBT) features Gate–Emitter ESD protection, Gate–Collector overvoltage protection from SMARTDISCRETES™ monolithic circuitry for usage as an **Ignition Coil Driver**.

- Temperature Compensated Gate–Drain Clamp Limits Stress Applied to Load
- Integrated ESD Diode Protection
- Low Threshold Voltage to Interface Power Loads to Logic or Microprocessors
- Low Saturation Voltage
- High Pulsed Current Capability

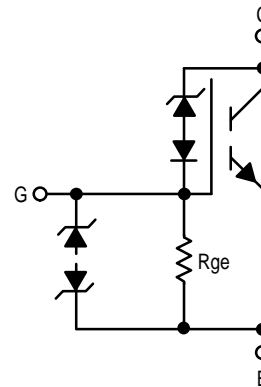

**MGP20N40CL**

**20 AMPERES  
 VOLTAGE CLAMPED  
 N-CHANNEL IGBT  
 V<sub>ce(on)</sub> = 1.8 VOLTS  
 400 VOLTS (CLAMPED)**

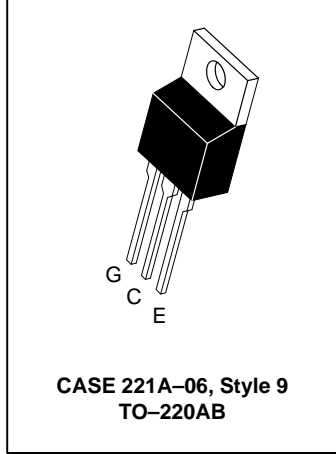

**MAXIMUM RATINGS** (T<sub>J</sub> = 25°C unless otherwise noted)

Rating	Symbol	Value	Unit
Collector–Emitter Voltage	V <sub>CES</sub>	CLAMPED	V <sub>dc</sub>
Collector–Gate Voltage	V <sub>CGR</sub>	CLAMPED	V <sub>dc</sub>
Gate–Emitter Voltage	V <sub>GE</sub>	CLAMPED	V <sub>dc</sub>
Collector Current — Continuous @ T <sub>C</sub> = 25°C	I <sub>C</sub>	20	A <sub>dc</sub>
Reversed Collector Current – pulse width < 100 μs	I <sub>CR</sub>	12	A <sub>pk</sub>
Total Power Dissipation @ T <sub>C</sub> = 25°C (TO-220)	P <sub>D</sub>	150	Watts
Electrostatic Voltage — Gate–Emitter	ESD	3.5	kV
Operating and Storage Temperature Range	T <sub>J</sub> , T <sub>stg</sub>	–55 to 175	°C

**THERMAL CHARACTERISTICS**

Thermal Resistance — Junction to Case – (TO-220) — Junction to Ambient	R <sub>θJC</sub> R <sub>θJA</sub>	1.0 62.5	°C/W
Maximum Lead Temperature for Soldering Purposes, 1/8" from case for 5 seconds	T <sub>L</sub>	275	°C
Mounting Torque, 6–32 or M3 screw	10 lbf•in (1.13 N•m)		

**UNCLAMPED INDUCTIVE SWITCHING CHARACTERISTICS**

Single Pulse Collector–Emitter Avalanche Energy @ Starting T <sub>J</sub> = 25°C @ Starting T <sub>J</sub> = 150°C	E <sub>AS</sub>	550 150	mJ
--	-----------------	------------	----

SMARTDISCRETES and TMOS are trademarks of Motorola, Inc.

This document contains information on a new product. Specifications and information herein are subject to change without notice.

**MGP20N40CL****ELECTRICAL CHARACTERISTICS** ( $T_C = 25^\circ\text{C}$  unless otherwise noted)

Characteristic	Symbol	Min	Typ	Max	Unit
<b>OFF CHARACTERISTICS</b>					
Collector-to-Emitter Breakdown Voltage ( $I_{\text{Clamp}} = 10\text{ mA}$ , $T_J = -40\text{ to }150^\circ\text{C}$ )	$BV_{\text{CES}}$	370	405	430	Vdc
Zero Gate Voltage Collector Current ( $V_{\text{CE}} = 350\text{ V}$ , $V_{\text{GE}} = 0\text{ V}$ , $T_J = 150^\circ\text{C}$ ) ( $V_{\text{CE}} = 15\text{ V}$ , $V_{\text{GE}} = 0\text{ V}$ , $T_J = 150^\circ\text{C}$ )	$I_{\text{CES}}$	— —	— —	500 100	$\mu\text{A}$
Resistance Gate-Emitter ( $T_J = -40\text{ to }150^\circ\text{C}$ )	$R_{\text{GE}}$	10k	16k	30k	$\Omega$
Gate-Emitter Breakdown Voltage ( $I_G = 2\text{ mA}$ )	$BV_{\text{GES}}$	11	13	15	$\pm\text{ V}$
Collector-Emitter Reverse Leakage ( $V_{\text{CE}} = -15\text{ V}$ , $T_J = 150^\circ\text{C}$ )	$I_{\text{CES}}$	—	—	50	mA
Collector-Emitter Reversed Breakdown Voltage ( $I_E = 75\text{ mA}$ )	$BV_{\text{CER}}$	26	40	120	V

**ON CHARACTERISTICS (1)**

Gate Threshold Voltage ( $V_{\text{CE}} = V_{\text{GE}}$ , $I_C = 1\text{ mA}$ ) ( $V_{\text{CE}} = V_{\text{GE}}$ , $I_C = 1\text{ mA}$ , $T_J = 150^\circ\text{C}$ )	$V_{\text{GE(th)}}$	1.0 0.75	1.7 —	2.2 1.8	V
Collector-Emitter On-Voltage ( $V_{\text{GE}} = 5\text{ V}$ , $I_C = 5\text{ A}$ ) ( $V_{\text{GE}} = 5\text{ V}$ , $I_C = 10\text{ A}$ ) ( $V_{\text{GE}} = 5\text{ V}$ , $I_C = 10\text{ A}$ , $T_J = 150^\circ\text{C}$ )	$V_{\text{CE(on)}}$	— — —	1.1 1.4 1.4	1.4 1.9 1.8	V
Forward Transconductance ( $V_{\text{CE}} > 5.0\text{ V}$ , $I_C = 10\text{ A}$ )	$g_{\text{fs}}$	10	18	—	S

**DYNAMIC CHARACTERISTICS**

Input Capacitance	$(V_{\text{CE}} = 25\text{ Vdc}$ , $V_{\text{GE}} = 0\text{ Vdc}$ , $f = 1.0\text{ MHz}$ )	$C_{\text{iss}}$	—	2800	—	pF
Output Capacitance		$C_{\text{oss}}$	—	200	—	
Transfer Capacitance		$C_{\text{rss}}$	—	25	—	

**SWITCHING CHARACTERISTICS (1)**

Total Gate Charge	$(V_{\text{CC}} = 280\text{ V}$ , $I_C = 20\text{ A}$ , $V_{\text{GE}} = 5\text{ V}$ )	$Q_g$	—	45	80	nC
Gate-Emitter Charge		$Q_{\text{gs}}$	—	8.0	—	
Gate-Collector Charge		$Q_{\text{gd}}$	—	20	—	
Turn-Off Delay Time	$(V_{\text{CC}} = 320\text{ V}$ , $I_C = 20\text{ A}$ , $L = 200\ \mu\text{H}$ , $R_G = 1\text{ K}\Omega$ )	$t_{\text{d(off)}}$	—	14	—	$\mu\text{s}$
Fall Time		$t_f$	—	4.0	—	
Turn-On Delay Time	$(V_{\text{CC}} = 14\text{ V}$ , $I_C = 20\text{ A}$ , $L = 200\ \mu\text{H}$ , $R_G = 1\text{ K}\Omega$ )	$t_{\text{d(on)}}$	—	2.0	—	$\mu\text{s}$
Rise Time		$t_r$	—	6.0	—	

(1) Pulse Test: Pulse Width  $\leq 300\ \mu\text{s}$ , Duty Cycle  $\leq 2\%$ .

TYPICAL ELECTRICAL CHARACTERISTICS

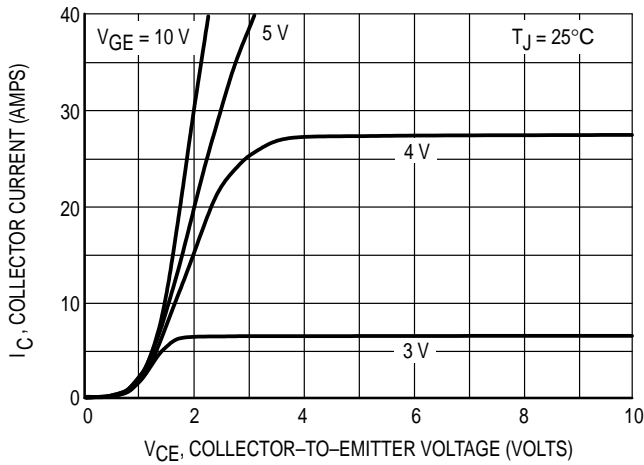

Figure 1. Output Characteristics,  $T_J = 25^\circ\text{C}$

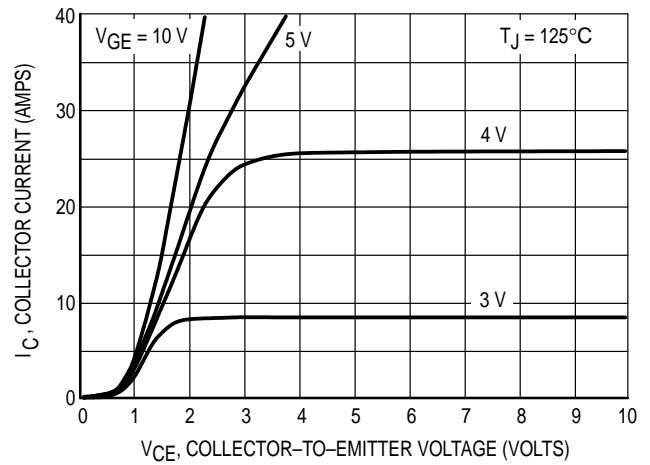

Figure 2. Output Characteristics,  $T_J = 125^\circ\text{C}$

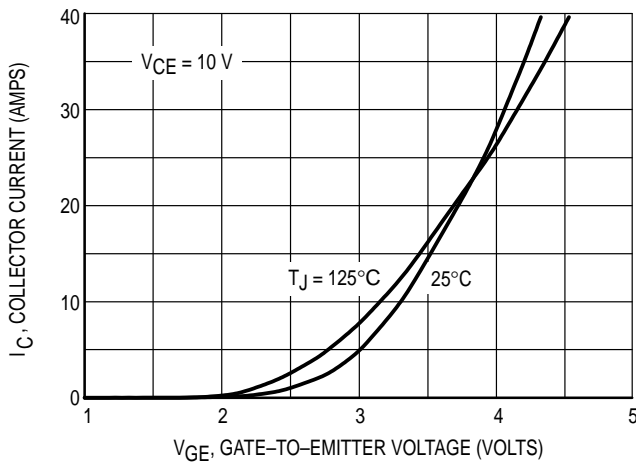

Figure 3. Transfer Characteristics

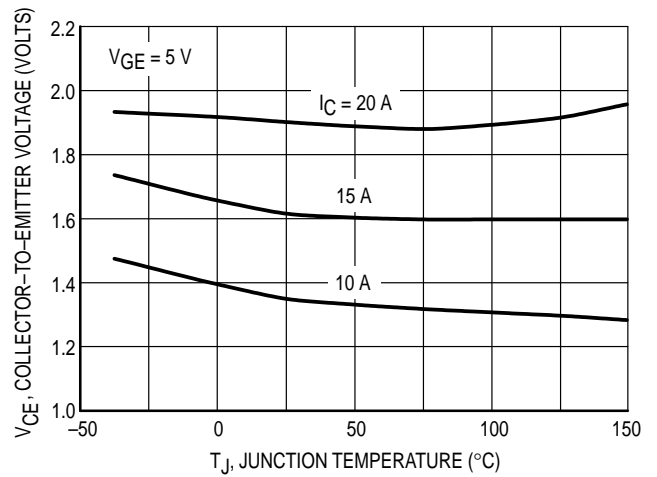

Figure 4. Collector-to-Emitter Saturation Voltage versus Junction Temperature

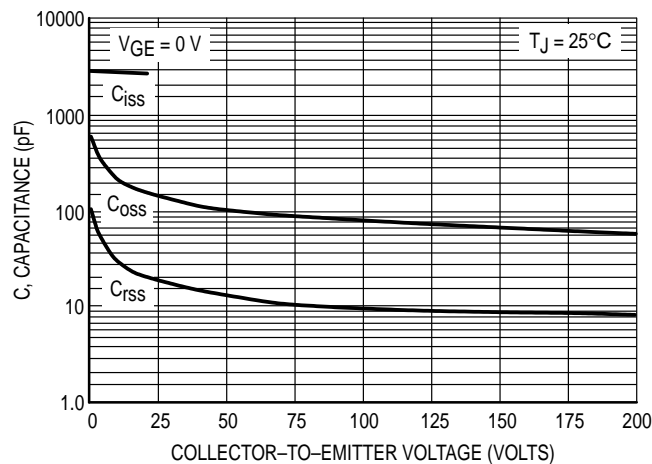
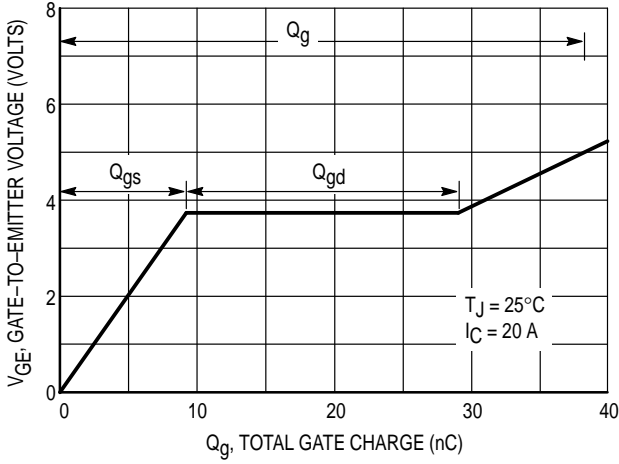
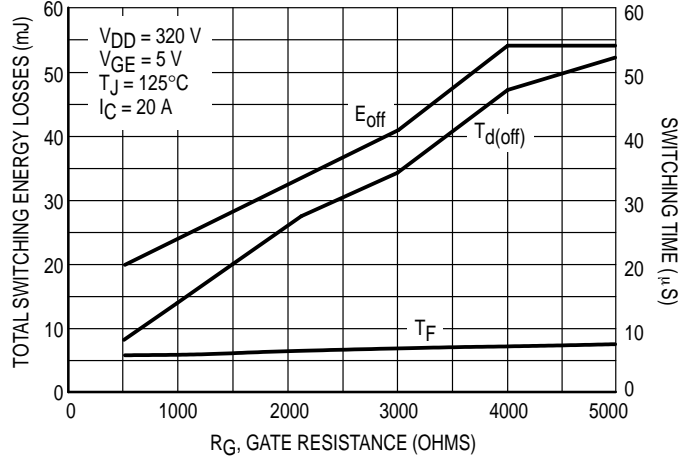

Figure 5. Capacitance Variation

**MGP20N40CL**



**Figure 6. Gate-to-Emitter and Collector-to-Emitter Voltage vs Total Charge**



**Figure 7. Total Switching Losses versus Gate Resistance**

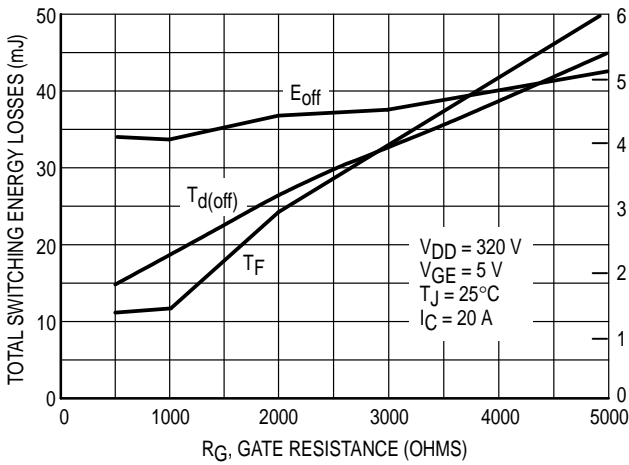

**Figure 8. Total Switching Losses versus Gate Resistance**

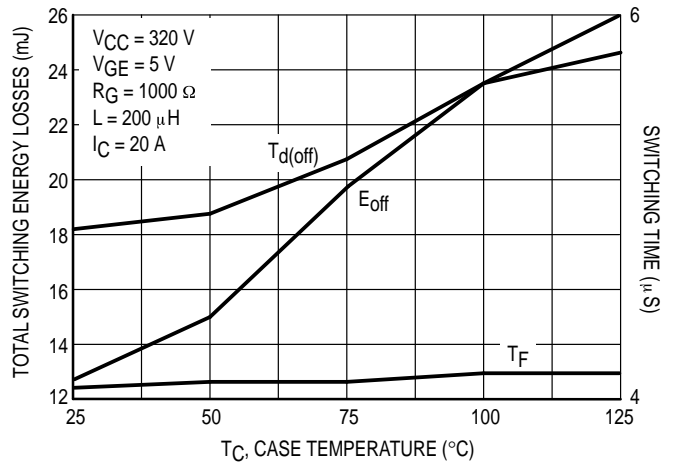

**Figure 9. Total Switching Losses versus Case Temperature**

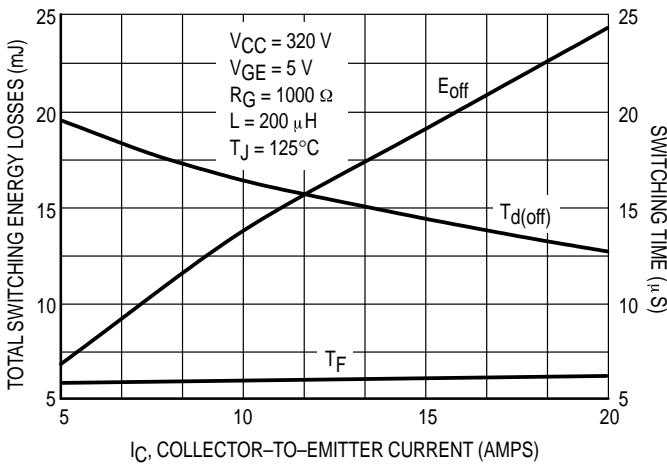

**Figure 10. Total Switching Losses versus Collector Current**

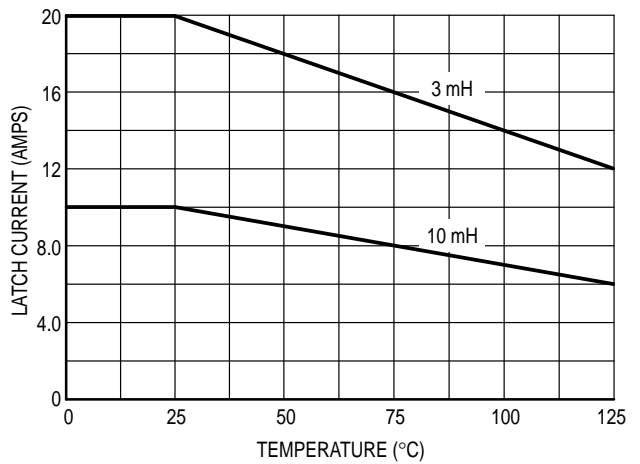

**Figure 11. Latch Current versus Temperature**

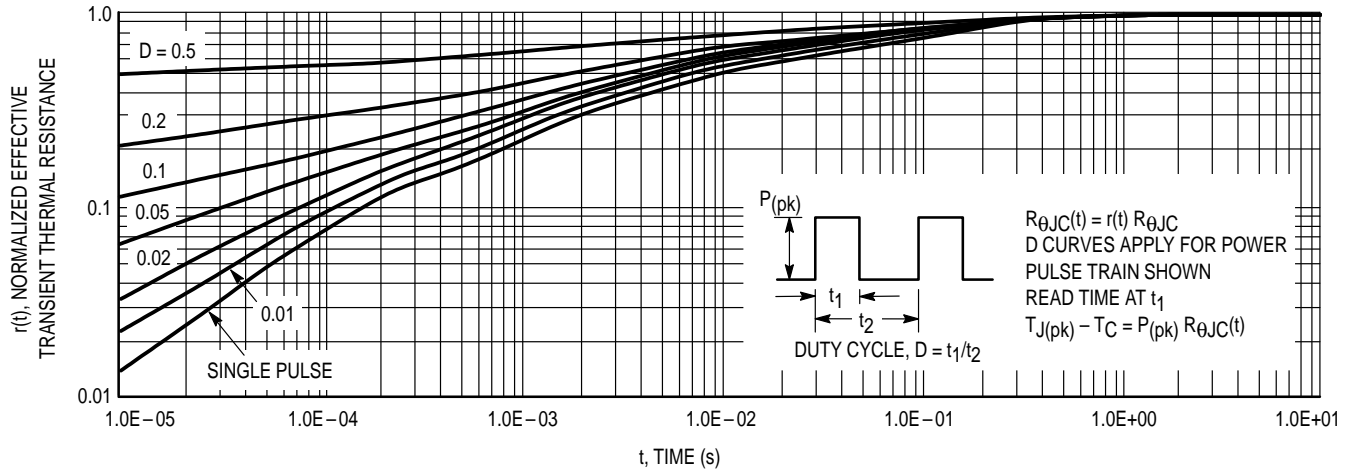
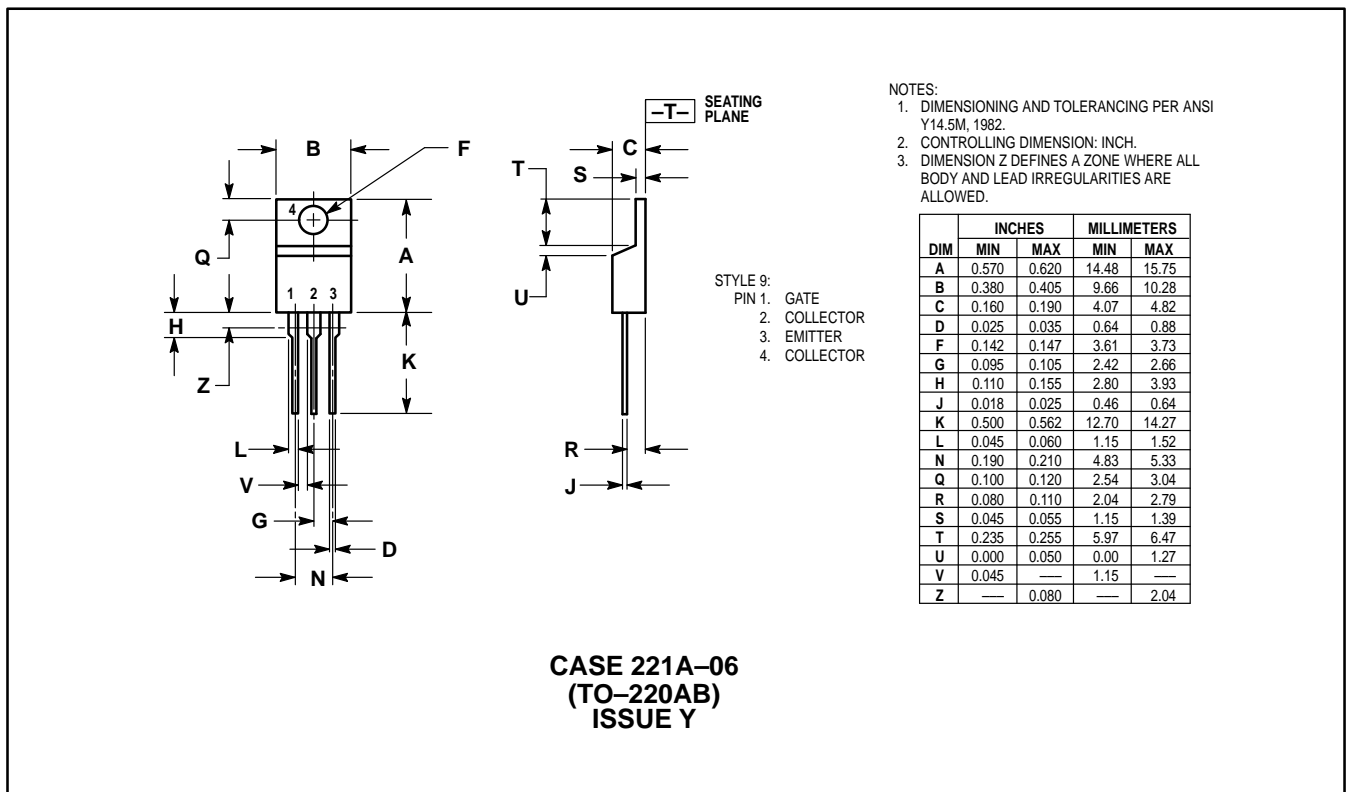



Figure 12. Thermal Response

PACKAGE DIMENSIONS



Motorola reserves the right to make changes without further notice to any products herein. Motorola makes no warranty, representation or guarantee regarding the suitability of its products for any particular purpose, nor does Motorola assume any liability arising out of the application or use of any product or circuit, and specifically disclaims any and all liability, including without limitation consequential or incidental damages. "Typical" parameters which may be provided in Motorola data sheets and/or specifications can and do vary in different applications and actual performance may vary over time. All operating parameters, including "Typicals" must be validated for each customer application by customer's technical experts. Motorola does not convey any license under its patent rights nor the rights of others. Motorola products are not designed, intended, or authorized for use as components in systems intended for surgical implant into the body, or other applications intended to support or sustain life, or for any other application in which the failure of the Motorola product could create a situation where personal injury or death may occur. Should Buyer purchase or use Motorola products for any such unintended or unauthorized application, Buyer shall indemnify and hold Motorola and its officers, employees, subsidiaries, affiliates, and distributors harmless against all claims, costs, damages, and expenses, and reasonable attorney fees arising out of, directly or indirectly, any claim of personal injury or death associated with such unintended or unauthorized use, even if such claim alleges that Motorola was negligent regarding the design or manufacture of the part. Motorola and  are registered trademarks of Motorola, Inc. Motorola, Inc. is an Equal Opportunity/Affirmative Action Employer.

Mfax is a trademark of Motorola, Inc.

**How to reach us:**

**USA/EUROPE/Locations Not Listed:** Motorola Literature Distribution;  
P.O. Box 5405, Denver, Colorado 80217. 303-675-2140 or 1-800-441-2447

**JAPAN:** Nippon Motorola Ltd.; Tatsumi-SPD-JLDC, 6F Seibu-Butsuryu-Center,  
3-14-2 Tatsumi Koto-Ku, Tokyo 135, Japan. 81-3-3521-8315

**Mfax™:** RMFAX0@email.sps.mot.com – TOUCHTONE 602-244-6609  
**INTERNET:** <http://Design-NET.com>

**ASIA/PACIFIC:** Motorola Semiconductors H.K. Ltd.; 8B Tai Ping Industrial Park,  
51 Ting Kok Road, Tai Po, N.T., Hong Kong. 852-26629298



**MOTOROLA**

